

0.5VA SEALED TRANSFORMER EE20 SERIES

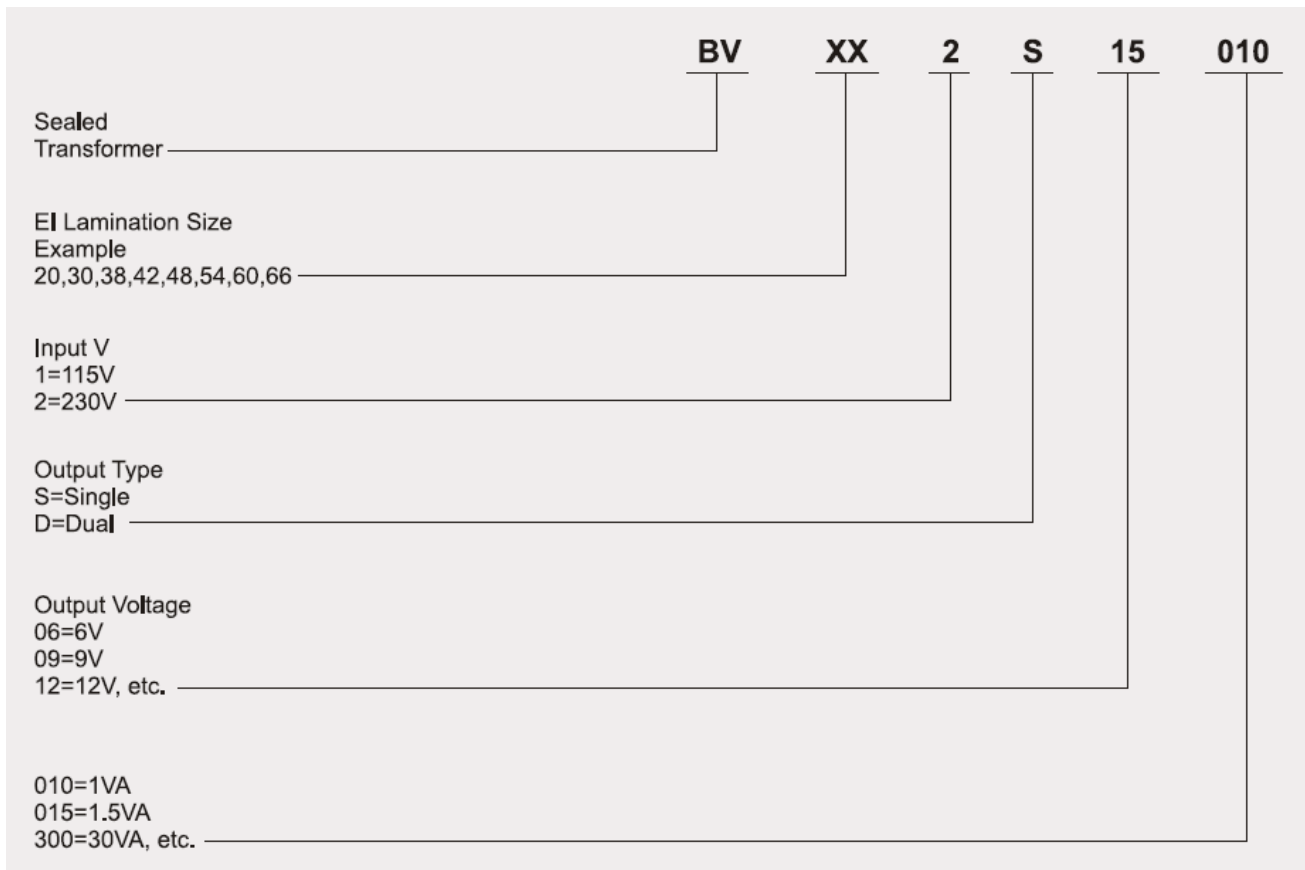

ORDERING CODE



FEATURES

- VDE,UL5085-1,-2,-3,CE Approved:
 UL file No.E214561 class 2/3
 VDE file No.40032785
 CQC file No.: CQC09001030821
- Vacuum Filling
- Split Bobbin Design
- Self-Extinguishing Plastics UL94V-0
- Dielectric Strength 4200Vrms
- Inherently Energy Limited
- Resin Class B IEC 85
 (20,000 h Testing to IEC 216)
- Conforms to EN 61558 and EN 60950
- 100% Production Tested

OUTLINE DIMENSIONS

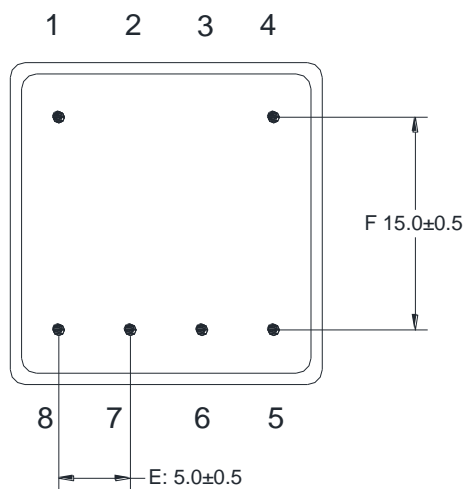
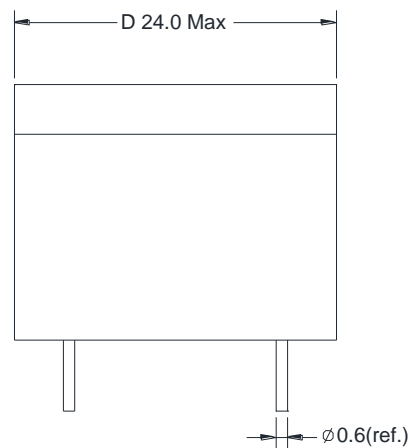
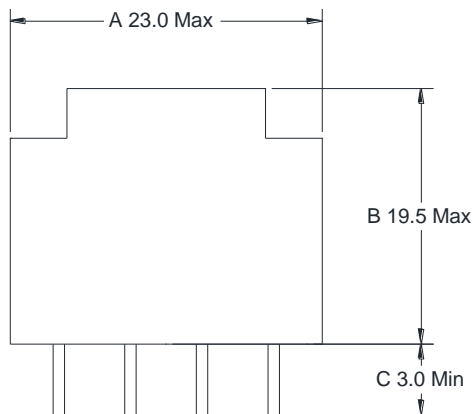

Dual outputs

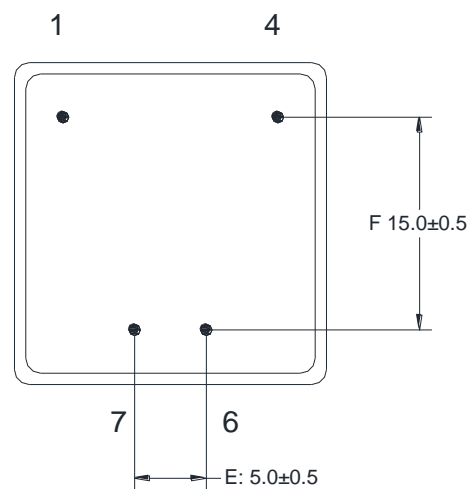

Single output

SCHEMATIC DIAGRAM:

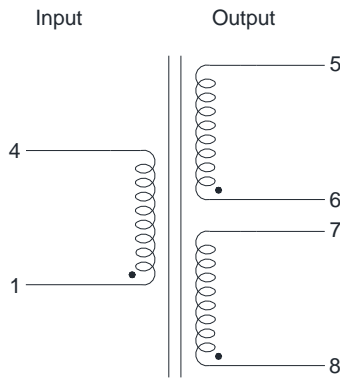

Dual outputs

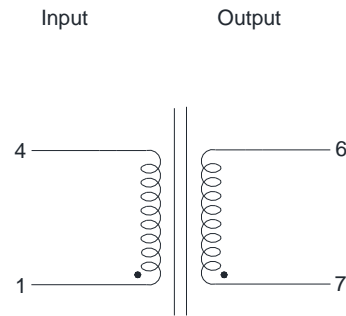

Single output

ELECTRONIC SPECIFICATIONS

Order Number	Input Voltage	SEC.Voltage (Vac)	Rated Power (VA)	No-load Voltage (V)	Ambient TEMP. (°C)	Weight (g)	Certificate			
							VDE	UL	CQC	CE
BV201S06005	115V 50/60Hz	6	0.5	11Max	T 70 B	40		●		●
BV201S09005	115V 50/60Hz	9	0.5	16.5Max	T 70 B	40		●		●
BV201S10005	115V 50/60Hz	10	0.5	17.4Max	T 70 B	40		●		●
BV201S12005	115V 50/60Hz	12	0.5	20.6Max	T 70 B	40		●		●
BV201S15005	115V 50/60Hz	15	0.5	26Max	T 70 B	40		●		●
BV201S18005	115V 50/60Hz	18	0.5	30Max	T 70 B	40		●		●
BV201S24005	115V 50/60Hz	24	0.5	41.1Max	T 70 B	40		●		●
BV201D06005	115V 50/60Hz	2x6	0.5	2x10.9Max	T 70 B	40		●		●
BV201D09005	115V 50/60Hz	2x9	0.5	2x16.4Max	T 70 B	40		●		●
BV201D10005	115V 50/60Hz	2x10	0.5	2x17.4Max	T 70 B	40		●		●
BV201D12005	115V 50/60Hz	2x12	0.5	2x20.6Max	T 70 B	40		●		●
BV201D15005	115V 50/60Hz	2x15	0.5	2x25.8Max	T 70 B	40		●		●
BV201D18005	115V 50/60Hz	2x18	0.5	2x29.5Max	T 70 B	40		●		●
BV201D24005	115V 50/60Hz	2x24	0.5	2x40.5Max	T 70 B	40		●		●
BV202S06005	230V 50/60Hz	6	0.5	11Max	T 70 B	40		●	●	●
BV202S09005	230V 50/60Hz	9	0.5	16.5Max	T 70 B	40		●	●	●
BV202S10005	230V 50/60Hz	10	0.5	17.4Max	T 70 B	40		●	●	●
BV202S12005	230V 50/60Hz	12	0.5	20.6Max	T 70 B	40		●	●	●
BV202S15005	230V 50/60Hz	15	0.5	26Max	T 70 B	40		●	●	●
BV202S18005	230V 50/60Hz	18	0.5	30Max	T 70 B	40		●	●	●
BV202S24005	230V 50/60Hz	24	0.5	41.1Max	T 70 B	40		●	●	●
BV202D06005	230V 50/60Hz	2x6	0.5	2x10.9Max	T 70 B	40		●	●	●
BV202D09005	230V 50/60Hz	2x9	0.5	2x16.4Max	T 70 B	40		●	●	●
BV202D10005	230V 50/60Hz	2x10	0.5	2x17.4Max	T 70 B	40		●	●	●
BV202D12005	230V 50/60Hz	2x12	0.5	2x20.6Max	T 70 B	40		●	●	●
BV202D15005	230V 50/60Hz	2x15	0.5	2x25.8Max	T 70 B	40		●	●	●
BV202D18005	230V 50/60Hz	2x18	0.5	2x29.5Max	T 70 B	40		●		●
BV202D24005	230V 50/60Hz	2x24	0.5	2x40.5Max	T 70 B	40		●		●